



MICROWAVE CORPORATION v00.0406



HMC507LP5 / 507LP5E

MMIC VCO w/ HALF FREQUENCY OUTPUT 6.65 - 7.65 GHz

Typical Applications

Low noise MMIC VCO w/Half Frequency, for:

- VSAT Radio
- Point to Point/Multi-Point Radio
- Test Equipment & Industrial Controls
- Military End-Use

Features

- Dual Output: $F_o = 6.65 - 7.65$ GHz
 $F_o/2 = 3.325 - 3.825$ GHz
- Pout: +13.5 dBm
- Phase Noise: -115 dBc/Hz @100 kHz Typ.
- No External Resonator Needed
- QFN Leadless SMT Package, 25 mm²

Functional Diagram

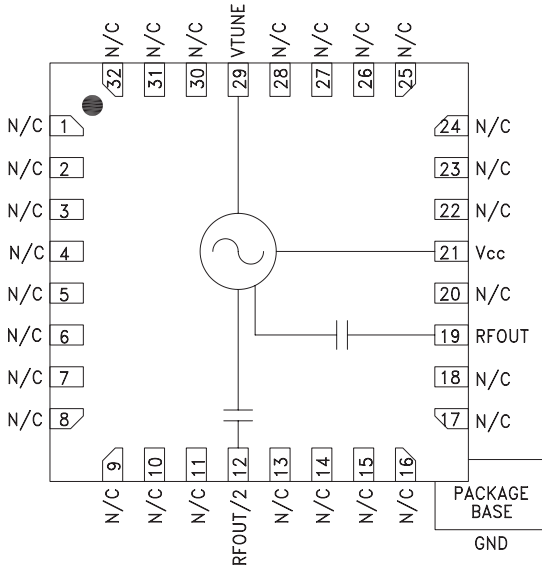

General Description

The HMC507LP5 & HMC507LP5E are GaAs InGaP Heterojunction Bipolar Transistor (HBT) MMIC VCOs. The HMC507LP5 & HMC507LP5E integrate resonators, negative resistance devices, varactor diodes and feature a half frequency output. The VCO's phase noise performance is excellent over temperature, shock, and process due to the oscillator's monolithic structure. Power output is +13.5 dBm typical from a +5V supply. The voltage controlled oscillator is packaged in a leadless QFN 5x5 mm surface mount package, and requires no external matching components.

Electrical Specifications, $T_A = +25^\circ C$, $V_{CC} = +5V$

| Parameter | Min. | Typ. | Max. | Units |
|--|------|---------------|------|-----------------|
| Frequency Range | | 6.65 - 7.65 | | GHz |
| | | 3.325 - 3.825 | | GHz |
| Power Output | +11 | | +16 | dBm |
| | +4 | | +10 | dBm |
| SSB Phase Noise @ 100 kHz Offset, $V_{tune} = +5V$ @ RFOUT | | -115 | | dBc/Hz |
| Tune Voltage | 2 | | 13 | V |
| Supply Current (I_{CC}) ($V_{CC} = +5.0V$) | 200 | 230 | 270 | mA |
| Tune Port Leakage Current ($V_{tune} = 13V$) | | | 10 | μA |
| Output Return Loss | | 2 | | dB |
| Harmonics/Subharmonics | | | | |
| | 1/2 | 35 | | dBc |
| | 2nd | 4 | | dBc |
| | 3rd | 24 | | dBc |
| Pulling (into a 2.0:1 VSWR) | | 8 | | MHz pp |
| Pushing @ $V_{tune} = 5V$ | | 15 | | MHz/V |
| Frequency Drift Rate | | 0.9 | | MHz/ $^\circ C$ |

For price, delivery, and to place orders, please contact Hittite Microwave Corporation:
20 Alpha Road, Chelmsford, MA 01824 Phone: 978-250-3343 Fax: 978-250-3373
Order On-line at www.hittite.com



v00.0406



HMC507LP5 / 507LP5E

MMIC VCO w/ HALF FREQUENCY OUTPUT 6.65 - 7.65 GHz

Frequency vs. Tuning Voltage, T= 25°C

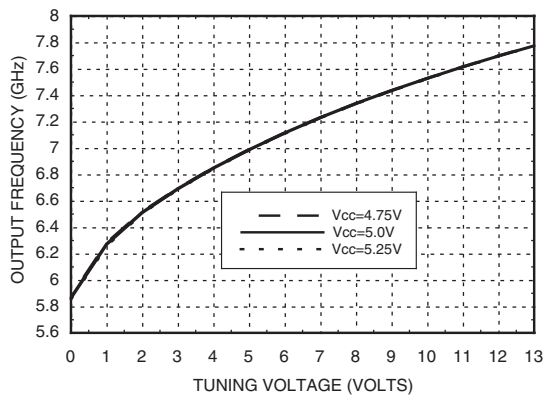

Frequency vs. Tuning Voltage, Vcc= +5V

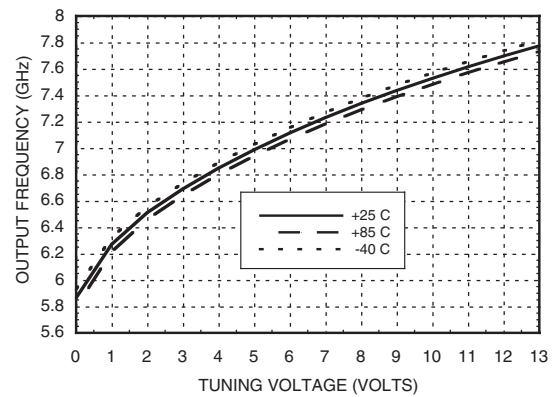

Sensitivity vs. Tuning Voltage, Vcc= +5V

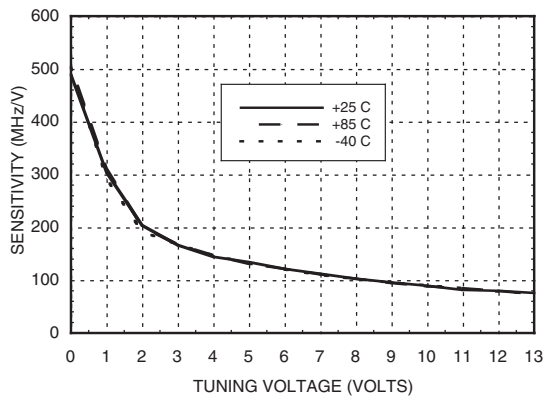

Output Power vs. Tuning Voltage, Vcc= +5V

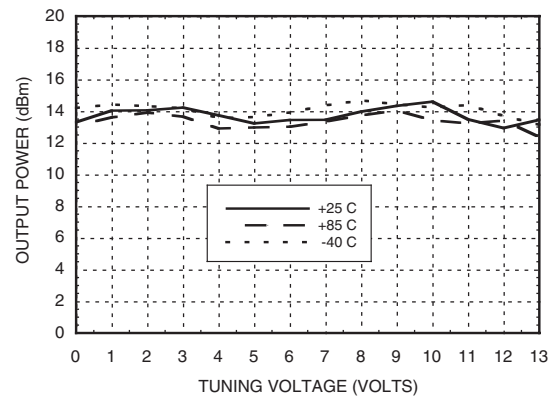

SSB Phase Noise vs. Tuning Voltage

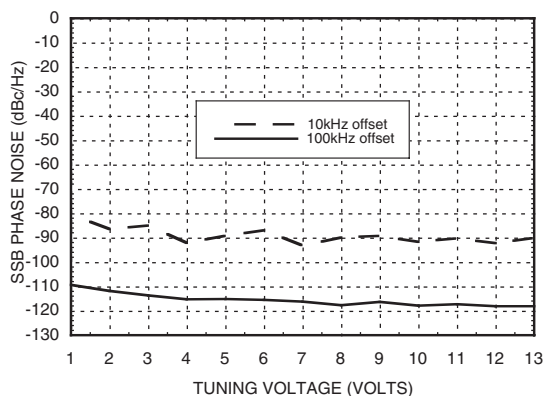

SSB Phase Noise @ Vtune = +5V

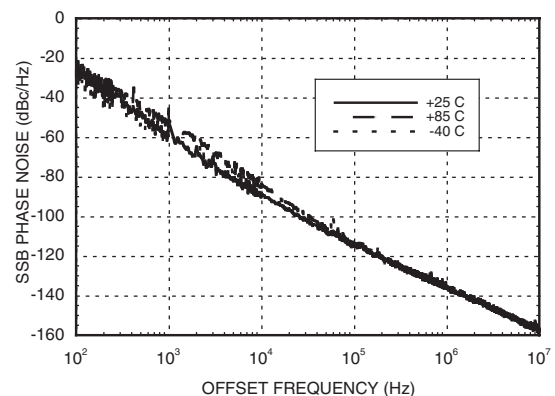

For price, delivery, and to place orders, please contact Hittite Microwave Corporation:
20 Alpha Road, Chelmsford, MA 01824 Phone: 978-250-3343 Fax: 978-250-3373
Order On-line at www.hittite.com



v00.0406



HMC507LP5 / 507LP5E

MMIC VCO w/ HALF FREQUENCY OUTPUT 6.65 - 7.65 GHz

**RFOUT/2 Frequency
vs. Tuning Voltage, Vcc= +5V**

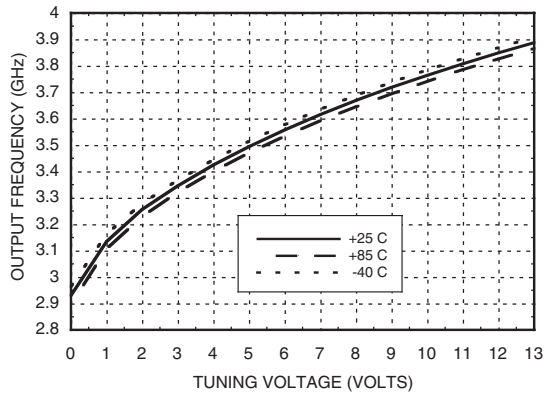

**RFOUT/2 Output Power
vs. Tuning Voltage, Vcc= +5V**

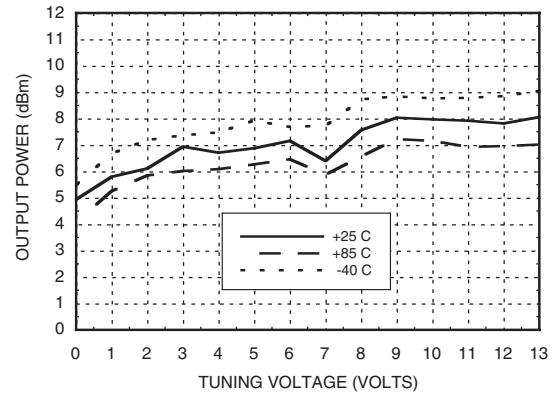

Absolute Maximum Ratings

| | |
|--|----------------|
| Vcc | +5.5 Vdc |
| Vtune | 0 to +15V |
| Junction Temperature | 135 °C |
| Continuous P _{diss} (T=85 °C) (derate 26.7 mW/C above 85 °C) | 1.35 W |
| Thermal Resistance (junction to ground paddle) | 37 °C/W |
| Storage Temperature | -65 to +150 °C |
| Operating Temperature | -40 to +85 °C |
| ESD Sensitivity (HBM) | Class 1A |

Typical Supply Current vs. Vcc

| Vcc (V) | I _{cc} (mA) |
|---------|----------------------|
| 4.75 | 210 |
| 5.0 | 225 |
| 5.25 | 242 |

Note: VCO will operate over full voltage range shown above.



**ELECTROSTATIC SENSITIVE DEVICE
OBSERVE HANDLING PRECAUTIONS**

HMC507LP5 / 507LP5E

MMIC VCO w/ HALF FREQUENCY OUTPUT 6.65 - 7.65 GHz

Outline Drawing

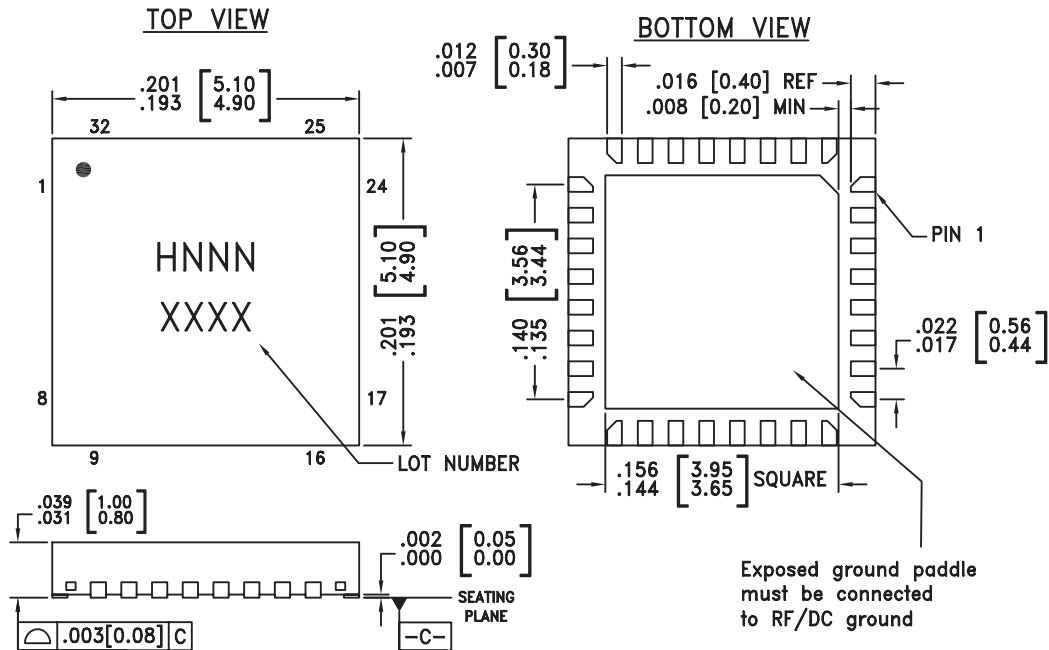

NOTES:

1. LEADFRAME MATERIAL: COPPER ALLOY
2. DIMENSIONS ARE IN INCHES [MILLIMETERS]
3. LEAD SPACING TOLERANCE IS NON-CUMULATIVE.
4. PAD BURR LENGTH SHALL BE 0.15mm MAXIMUM.
PAD BURR HEIGHT SHALL BE 0.05mm MAXIMUM.
5. PACKAGE WARP SHALL NOT EXCEED 0.05mm.
6. ALL GROUND LEADS AND GROUND PADDLE MUST BE SOLDERED TO PCB RF GROUND.
7. REFER TO HITTITE APPLICATION NOTE FOR SUGGESTED LAND PATTERN.

Package Information

| Part Number | Package Body Material | Lead Finish | MSL Rating | Package Marking ^[3] |
|-------------|--|---------------|---------------------|--------------------------------|
| HMC507LP5 | Low Stress Injection Molded Plastic | Sn/Pb Solder | MSL1 ^[1] | H507 XXXX |
| HMC507LP5E | RoHS-compliant Low Stress Injection Molded Plastic | 100% matte Sn | MSL1 ^[2] | H507 XXXX |

[1] Max peak reflow temperature of 235 °C

[2] Max peak reflow temperature of 260 °C

[3] 4-Digit lot number XXXX



MICROWAVE CORPORATION v00.0406



HMC507LP5 / 507LP5E

MMIC VCO w/ HALF FREQUENCY OUTPUT 6.65 - 7.65 GHz

Pin Descriptions

| Pin Number | Function | Description | Interface Schematic |
|-------------------------------|----------|---|---------------------|
| 1-11, 13-18, 20, 22-28, 30-32 | N/C | No Connection. These pins may be connected to RF/DC ground. Performance will not be affected. | |
| 12 | RFOUT/2 | Half frequency output (AC coupled). | |
| 19 | RFOUT | RF output (AC coupled). | |
| 21 | Vcc | Supply Voltage, +5V | |
| 29 | VTUNE | Control Voltage Input. Modulation port bandwidth dependent on drive source impedance. | |
| | GND | Package bottom has an exposed metal paddle that must be connected to RF/DC ground. | |

Evaluation PCB

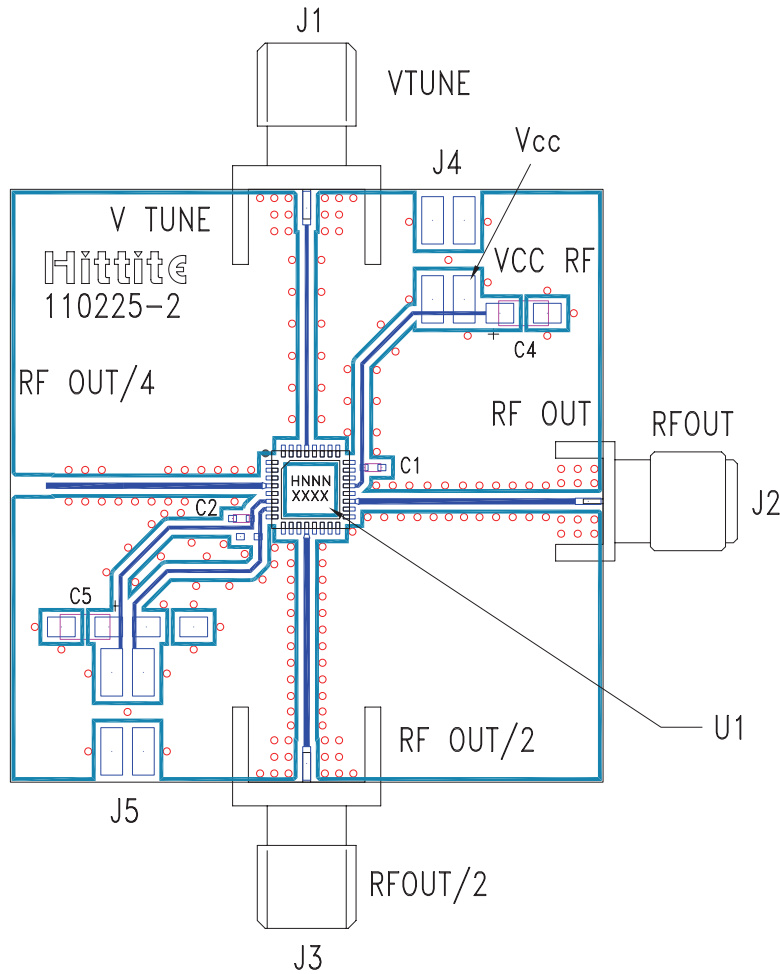

List of Materials for Evaluation PCB 110227 [1]

| Item | Description |
|---------|--------------------------------|
| J1 - J3 | PCB Mount SMA RF Connector |
| J4, J5 | 2 mm DC Header |
| C1 - C2 | 100 pF Capacitor, 0402 Pkg. |
| C4 - C5 | 2.2 μ F Tantalum Capacitor |
| U1 | HMC507LP5 / HMC507LP5E VCO |
| PCB [2] | 110225 Eval Board |

[1] Reference this number when ordering complete evaluation PCB

[2] Circuit Board Material: Rogers 4350

The circuit board used in the final application should use RF circuit design techniques. Signal lines should have 50 ohm impedance while the package ground leads and backside ground paddle should be connected directly to the ground plane similar to that shown. A sufficient number of via holes should be used to connect the top and bottom ground planes. The evaluation circuit board shown is available from Hittite upon request.